

# JA9100 BALCÃO 120

# Instruções de montagem Assembly Instructions / Instrucciones de Montaje



**DELMARCO**



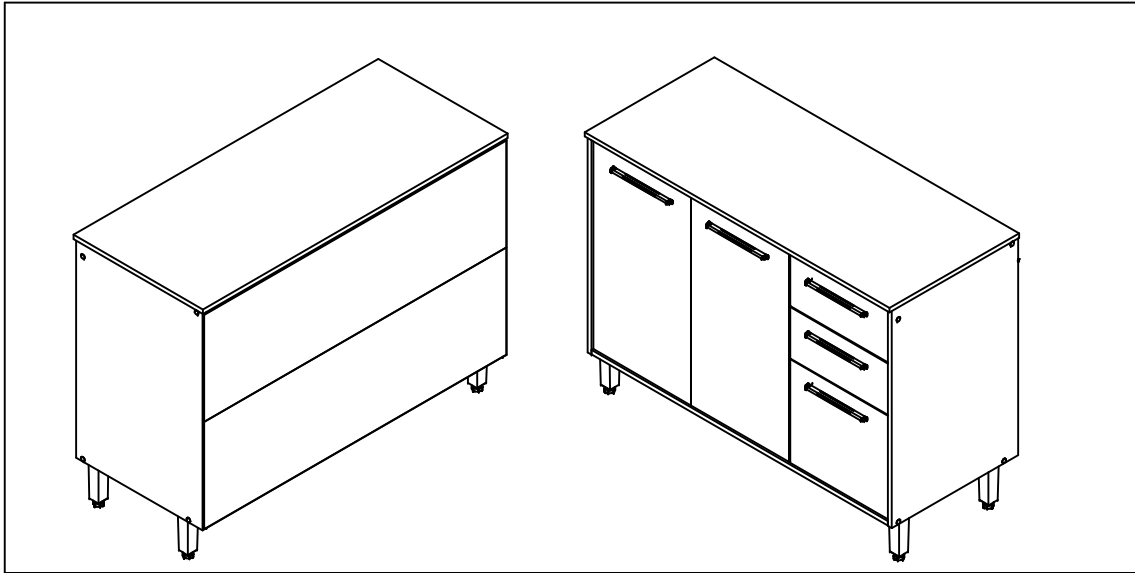



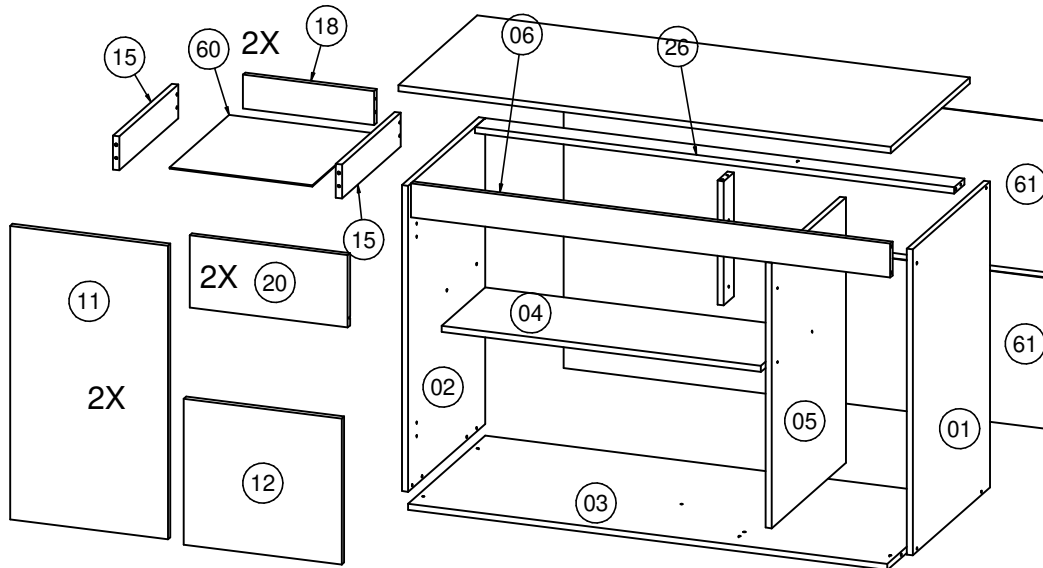





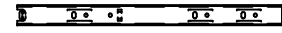



1

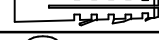

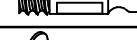
REV.: 00  
DATA: 28/08/2023

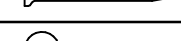

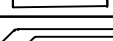
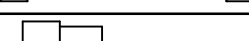
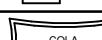
LISTA DE PEÇAS / LISTA DE PIEZAS / PARTS LIST			
COD	DESCRIÇÃO / DESCRIPCIÓN / DESCRIPTION	DIM / DIM / DIM	QTD
01	LATERAL DIREITA/ LATERAL DERECHO/ RIGHT SIDE	740 x 497 x 15	1
02	LATERAL ESQUERDA/ LATERAL IZQUIERDA/ LEFT SIDE	740 x 497 x 15	1
03	BASE/ BASE/ BASE	1168 x 497 x 15	1
04	PRATELEIRA/ ESTANTE/ SHELF	778 x 280 x 15	1
05	DIVISÃO/ DIVISIÓN/ DIVISION	642 x 479 x 15	1
06	TRAVESSA/ TRAVESAÑO/ CROSSPIECE	1168 x 82 x 15	1
07	PILASTRA/ TRAVESAÑO/ CROSSPIECE	300 x 65 x 15	1
10	TAMPO/ TAPA/ TOP	1200 x 510 x 15	1
11	PORTA/ PUERTA/ DOOR	710 x 385 x 15	2
12	PORTA/ PUERTA/ DOOR	353 x 385 x 15	1
15	LATERAL GAVETA/ LAT CAJÓN/ DRAWER SIDE	380 x 82 x 15	4
18	COSTA GAVETA/ TRASERA DEL CAJÓN/ BACK OF THE DRAWER	320 x 82 x 15	2
20	FRENTE GAVETA/ FRENTE DEL CAJÓN/ FRONT OF THE DRAWER	175 x 385 x 15	2
26	TRAVESSA TRASEIRA/ TRAVESAÑO/ CROSSPIECE	1168 x 65 x 15	1
60	FUNDO GAVETA/ FONDO DEL CAJÓN/ BOTTOM OF THE DRAWER	348 x 383 x 3	2
61	COSTA/ FONDO/ BACK	1190 x 365 x 3	2

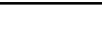
LISTA DE FERRAGENS / LISTA DE ACCESORIOS / HARDWARE LIST		
COD	DESCRIÇÃO / DESCRIPCIÓN / DESCRIPTION	QTD
A	 CAVILHA Ø6X30 CLAVIJA Ø6X30 WOOD DOWEL Ø6X30	21
B	 PARAFUSO CC 3,5X14 REBAIXE TORNILLO CC 3,5X14 SCREW CC 3,5X14	48
C	 PARAFUSO CC 3,5X40 TORNILLO CC 3,5X40 SCREW CC 3,5X40	15
CR	 CORREDIÇA CORREDEIRA SLIDE	2
DA	 DOBRADIÇA BISAGRA HINGE	6
E	 PARAFUSO CF 3,5X30 TORNILLO CF 3,5X30 SCREW CF 3,5X30	10
F	 PARAFUSO CF 4,5X50 TORNILLO CF 4,5X50 SCREW CF 4,5X50	7
G	 SUPORTE FIXAÇÃO SOPORTE DE FIJACION FIXING SUPPORT	2
H	 PROTEÇÃO SUP CANTONEIRA PROTECCIÓN ANGLE BRACKET	2
I	 BUCHA PLÁSTICA CASQUILLO BUSHING	2
J	 TAMBOR MINIFIX TUERCA MINIFIX MINIFIX DRUM	4
K	 PARAFUSO MINIFIX TORNILLO MINIFIX SCREW MINIFIX	4
L	 CANTONEIRA 18X18 ESQUINERO 18X18 CORNER 18X18	6
M	 PREGO 10X10 CLAVO 10X10 NAIL	50
N	 ADESIVO TAPA FURO ADHESIVO STICKER	8
PE	 PÉ PIE FOOT	5
PX	 PUXADOR TIRADOR HANDLE	5
S	 SUPORTE PRATELEIRA SOPORTE DE ESTANTE SHELF SUPPORT	4
V	 COLA PEGAMENTO GLUE	1
Y	 PARAFUSO CC 3,5X30 TORNILLO CC 3,5X30 SCREW CC 3,5X30	5
Z	 BATENTE SILICONE SILICONE STOP TAPON SILICONA	2

**"IMPORTANTE  
LER COM  
ATENÇÃO  
E GUARDAR  
PARA EVENTUAIS  
CONSULTAS".**  
"IMPORTANTE LEER CON  
ATENCIÓN Y GUARDAR PARA  
EVENTUALES CONSULTAS".  
"IMPORTANT TO READ  
CAREFULLY AND SAVE FOR  
ANY QUERIES".



**FERRAMENTAS NECESSÁRIAS:  
HERRAMIENTAS NECESSARIAS:  
NECESSARY TOOLS:**

